

VEHICLE DETAILS

Chassis number ¹: S14-001238

Manufacture date: 1993-10

Make: NISSAN

Model: SILVIA

Body: E-S14

Grade: K's

Engine: SR20DET

Drive: 2WD

Transmission: F5

Title information ²:



Deregistered to Export



Accident / Repair:



Problem found



Odometer rollback:



No problem



Manufacturer recall:



No problem



Safety grade ³:



No data



Contamination risk:



No problem



This vehicle does not qualify for Buyback Guarantee

Average Market Price



Unfortunately, this vehicle does not qualify for our Buyback Guarantee program.









¥890,000

[About Buyback Guarantee](#)

This CAR VX Vehicle History Report is based only on Information supplied to CAR VX, LTD and available as of 2020-10-20 12:32:44. Other information about this vehicle, including problems, may not have been reported to CAR VX, LTD . Use this report as one important tool, along with a vehicle inspection and test drive, to make a better decision about your next used car.



ACCIDENT / REPAIR HISTORY

Problem type	Reported	Date reported	Data source	Details	Airbag
Collision	 Reported				
—	—	2020-09-24	USS Tokyo	Repaired	OK
Malfunction	 Not reported				
Theft	 Not reported				
Fire damage	 Not reported				
Water damage	 Not reported				
Hail damage	 Not reported				

ODOMETER READINGS HISTORY

Date reported	Data source	Odometer reading (Km)
2015-03-10	MLIT	124100
2017-04-03	MLIT	132800
2020-09-24	USS Tokyo	141417

USE HISTORY

Use in the contaminated regions ⁴	Radioactive contamination test fail ⁵	Commercial use
 Not reported	 Not reported	 Not reported

DETAILED HISTORY

Event date	Location	Odometer reading (Km)	Data source	Details
1993-10			NISSAN	Manufactured
1994-03			MLIT	First registration
2015-03-10		124100	MLIT	Inspection
2017-04-03		132800	MLIT	Inspection

2018-09-21	Sapporo		MLIT	Last registration
2020-09-24	Chiba	141417	USS Tokyo	Auctioned

MANUFACTURER RECALL HISTORY

Date reported	Data source	Affected part	Details
---------------	-------------	---------------	---------

 Not reported

VEHICLE ASSESSMENT ⁶

Overall Collision Safety Ratings

Driver's seat			Front passenger's seat		
Points	Evaluation	Goal average	Points	Evaluation	Goal average

* In order to accurately differentiate between the evaluations of different vehicles, a standard is set based on current technology. Up to 6 points out of 12 is given level 1 and the rest of the range is divided up into equal parts, which are respectively assigned to level 2 (more than 6 points but 7.5 or less), level 3 (more than 7.5 points but 9 or less), level 4 (more than 9 points but 10.5 or less) or level 5 (more than 10.5 points).

Braking performance tests ⁷

Dry road



Wet road



VEHICLE SPECIFICATION

1st gear ratio

2nd gear ratio

3rd gear ratio

4th gear ratio

5th gear ratio

6th gear ratio

Additional notes

Airbag position,
capacity

Body rear overhang

Body type

COUPE

Chassis number embossing position		Classification code	261
Cylinders	4	Displacement	1998cc
Electric engine type		Electric engine maximum output	
Electric engine maximum torque		Electric engine power	
Engine maximum power	220ps(162kW)/6000rpm	Engine maximum torque	28.0kg·m(274.6N·m)/4800rpm
Engine model	SR20	Frame type	
Front shaft weight	680	Front shock absorber type	
Front stabilizer type		Front tires size	205/55R16 89V
Front tread	1480	Fuel consumption	11.4km/l
Fuel tank equipment	65	Grade	K's
Height	129	Length	450
Main brakes type		Make	NISSAN
Maximum speed		Minimum ground clearance	
Minimum turning radius	4.8m	Model	SILVIA
Model code	E-S14	Mufflers number	
Rear shaft weight	540	Rear shock absorber type	
Rear stabilizer type		Rear tires size	205/55R16 89V
Rear tread	1470	Reverse ratio	
Riding capacity	4	Side brakes type	
Specification code	7515	Stopping distance	
Transmission type	F5	Weight	1220
Wheel alignment	2WD	Wheelbase	2525
Width	173		

Date:	2020-09-24	Lot #:	10165
Auction name:	USS Tokyo	Region:	Chiba
Make:	NISSAN	Model:	SILVIA
Reg. year:	1994	Mileage (km):	141417
Displacement (cc):	2000	Transmission:	F5
Color:	GREEN	Model code:	S14
Result:	available	Auction grade:	R
Problem type:	Collision	Problem scale:	Repaired
Contaminated:	No	Airbag:	OK

PHOTOS AND AUCTION SHEETS

M Tコーナー

10165	車歴 (自家用以外は記入)	排気量	2000	型式	E-S14	評価点	3
	初年度登録年月	車名	グレード	2WD	4WD	内装	
6/3月	シルビア	2	KS				
車検	年	月	シフト	F5	純正	S R 純AW (P) (PW)	
走行	141,417	km	冷房	AAC	カワ	TV ナビ	エアB
外元色	グリーン	色番	カラー	販売店	有・無	セールスポイント	
色	グリーン	FN2	内装色			303770896"・057070896"	
燃料	ガソリン	軽油				フロント129-73- HKS V70	
車種	輸入区分	ハンドル	名義変更期限	月	日	HKS9-ボクサー・HKS EVC	
ディーラー	並行	左・右				ビヨン VRCII・Defi 4速X-ター	
リサイクル	預託金	8830円	4人			大量サンダー・大容量オイルポン	
<p>○注意事項 (修理・不具合箇所および仕様等)</p> <p>・ロールオーバー防止・外ホース ・70474729-・外注9-87 ・外LSB・外1814AW・外777-20AW ・エンジン220? 改造多数 要現車確認</p> <p>○検査員報告 (USS使用車) 有願・129</p> <p>① 3-17-199 ② 3-17-199 ③ 3-17-199 ④ 3-17-199 ⑤ 3-17-199 ⑥ 3-17-199 ⑦ 3-17-199 ⑧ 3-17-199 ⑨ 3-17-199 ⑩ 3-17-199 ⑪ 3-17-199 ⑫ 3-17-199 ⑬ 3-17-199 ⑭ 3-17-199 ⑮ 3-17-199 ⑯ 3-17-199 ⑰ 3-17-199 ⑱ 3-17-199 ⑲ 3-17-199 ⑳ 3-17-199 ㉑ 3-17-199 ㉒ 3-17-199 ㉓ 3-17-199 ㉔ 3-17-199 ㉕ 3-17-199 ㉖ 3-17-199 ㉗ 3-17-199 ㉘ 3-17-199 ㉙ 3-17-199 ㉚ 3-17-199 ㉛ 3-17-199 ㉜ 3-17-199 ㉝ 3-17-199 ㉞ 3-17-199 ㉟ 3-17-199 ㊱ 3-17-199 ㊲ 3-17-199 ㊳ 3-17-199 ㊴ 3-17-199 ㊵ 3-17-199 ㊶ 3-17-199 ㊷ 3-17-199 ㊸ 3-17-199 ㊹ 3-17-199 ㊺ 3-17-199 ㊻ 3-17-199 ㊼ 3-17-199 ㊽ 3-17-199 ㊾ 3-17-199 ㊿ 3-17-199</p>							
登録地				S14-00/238			
車台地				S14-00/238			
シリアル地				S14-00/238			
台内寸約				X X (cm)			
長さ				高さ			
				← (車検証上の寸法)			

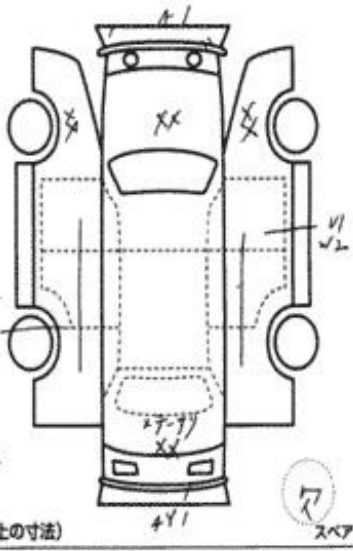



¹ Chassis number – a unique identification number of the vehicle in Japan (same as VIN in the USA or Europe)

² Title information:

Registered – qualified for driving in Japan

Deregistered Temporarily – not qualified for driving in Japan, usually a temporary title during the ownership change

Deregistered Completely – not qualified for driving in Japan, the vehicle is determined to be scrapped

Deregistered to Export – not qualified for driving in Japan, the vehicle is determined to be exported

³ Determining the overall collision safety performance evaluation – For the driver's seat, the results of the full-wrap frontal collision test, offset frontal collision test, and side collision test are added together and evaluated to 6 different levels. For the Frontal passenger's seat, the results of the full-wrap frontal collision test and the side collision test (results for the driver's or the front passenger's seat are used) are added together and evaluated to 6 different levels.

Regular vehicle inspection – All vehicles in Japan must undergo regular vehicle inspections (shaken). New cars need to be tested after three years, and then vehicles must be tested every two years thereafter. A vehicle inspection (shaken) is compulsory for all vehicles with an engine size over 250cc. It ensures that all vehicles on the road are properly maintained and safe to drive. The test also checks that vehicles have not been illegally modified; if they are found to have been modified, they are not allowed on the road.

⁴ Use in the contaminated regions – The Fukushima Daiichi nuclear disaster was a catastrophic failure at the Fukushima I Nuclear Power Plant on 11 March 2011, resulting in a meltdown of three of the plant's six nuclear reactors. As a result, some areas in the following prefectures were contaminated: Fukushima, Miyagi, Ibaraki, Tochigi.

⁵ Radioactive contamination test – radioactive contamination inspection that was started in July 2011 as a preventive measure for exporting contaminated vehicles from Japan. The inspection is being conducted since in all sea ports of Japan under the supervision of The Japan Harbor Transportation Association (JHTA).

MLIT – Ministry of Land, Infrastructure, Transport and Tourism.

⁶ Japan New Car Assessment Program – the Ministry of Land, Infrastructure, Transport and Tourism (MLIT) and the National Agency for Automotive Safety & Victims' Aid (NASVA) have taken measures for safety, one of which is to assess commercially available vehicles through a variety of safety performance tests and release the resulting information compiled into the "New Car Assessment Program". The objective of Japan New Car Assessment Program is to increase the use of safe automobiles by providing an environment in which users can easily select such vehicles. This also promotes the development of safer vehicles by automobile manufacturers. Neck injury protection for rear-end collision performance test, rear seat passenger's protection for frontal collision performance test, rear passenger's seat belt usability evaluation test and seat belt reminder for passengers evaluation test are started in FY2009.

⁷ Braking Performance Tests – Braking performance is determined by the shortness of the distance in which a vehicle can stop and the stability of the vehicle at the time of braking. This test is performed under wet and dry road conditions for a vehicle which has both a driver and a front passenger. The distance it takes for the vehicle to stop and the stability of the vehicle at the time of braking is evaluated for when the vehicle is stopped abruptly while traveling at a speed of 100km/h. The stopping distance and vehicle speed have been measured by using GPS since FY2009.

CAR VX, LTD DEPENDS ON ITS SOURCES FOR THE ACCURACY AND RELIABILITY OF ITS INFORMATION. THEREFORE, NO RESPONSIBILITY IS ASSUMED BY CAR VX, LTD OR ITS AGENTS FOR ERRORS OR OMISSIONS IN THIS REPORT. CAR VX, LTD FURTHER EXPRESSLY DISCLAIMS ALL WARRANTIES, EXPRESS OR IMPLIED, INCLUDING ANY IMPLIED WARRANTIES OF MERCHANTABILITY OR FITNESS FOR A PARTICULAR PURPOSE.

© 2014-2020 Car VX Limited. All rights reserved.